

# MTX<sup>®</sup>

## AUDIO

 [mtxaudio.eu](http://mtxaudio.eu)

 [twitter.com/MTXEurope](https://twitter.com/MTXEurope)

 [facebook.com/MTXEurope](https://facebook.com/MTXEurope)



# RFL12

**9000W Peak, 3000W RMS 30cm (12") 2Ω Subwoofer**  
**Designed by MTX in Phoenix, AZ - USA**

## ● RFL12 Parameters :

(F) Paramètres, (E) Parameter, (D) Parameter, (I) Parametri, (P) Parâmetros, (NL) Parameters, (RUS) Параметры, (RO) Parametrii, (FIN) Parametrit, (PL) Parametry

- Fs : 35 Hz
- Re : 2 Ω
- Z : 2 Ω
- Qms : 7,61
- Qes : 0,37
- Qts : 0,35
- Vas : 14,6 liters
- Prms : 3000 Watts
- Mms : 495,8 grams
- Cms : 0,042 mm/N
- Bl : 25 N/A
- Sd : 497,7 cm<sup>2</sup>
- Vd : 0,747 liter
- Xmax : 15,0 mm
- SPL 2,83V/1m : 90,0 dB

## ● RFL12 Dimensions :

(F) Dimensions, (E) Dimensiones, (D) Abmessungen, (I) Dimensioni, (P) Dimensões, (NL) Afmetingen, (RUS) Размеры, (RO) Dimensiuni, (FIN) Mitat, (PL) Wymiary

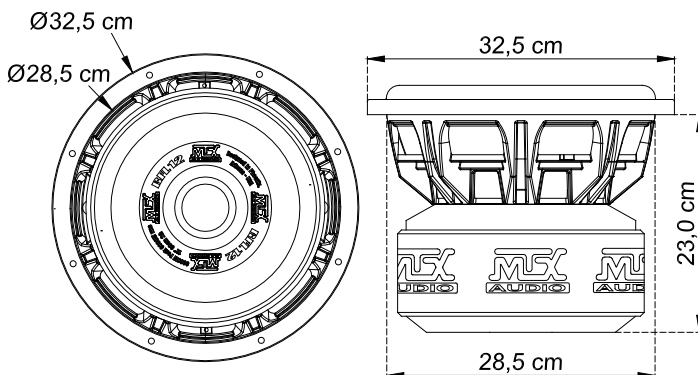

## ● RFL12 Recommended amp : RT1000.1D

**RFL12 Recommended amp power : 900-1800W RMS**

(F) Puissance ampli recommandée, (E) La Potencia nominal recomendada, (D) Empfohlene Verstärkerleistung, (I) Potenza consigliata dell'amplificatore, (P) Potência de amplificação recomendada, (NL) Advies versterkervermogen, (RUS) Рекомендуемая мощность усилителя, (RO) Puterea recomandata a amplificatorului, (FIN) Suositeltava vahvistinteho, (PL) Rekomendowana moc wzmacniacza

## ● RFL12 Wiring configurations :

(F) Exemples de câblage, (E) Configuración del cableado, (D) Verkabelung, (I) Configurazione di collegamento, (P) Configuração de cablagem, (NL) Aansluit mogelijkheden, (RUS) Схема подключения, (RO) Configuratia firelor, (FIN) Johdotuksen kokoonpano, (PL) Konfiguracja połączeń

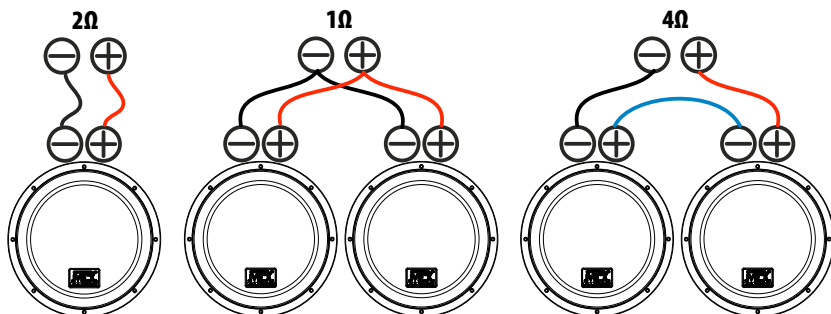

## ● #1 Sealed Enclosure : SQ, to play clean and deep !

(F) Caisson clos pour qualité sonore et linéarité, (E) Cajón Sellado, (D) Geschlossenes Gehäuse, (I) Cassa a sospensione pneumatica, (P) Caixa fechada, (NL) Gesloten behuizing, (RUS) Закрытый корпус, (RO) Incinta in compresie, (FIN) Suljettu kotelo, (PL) Obudowa zamknięta

# 36 liters

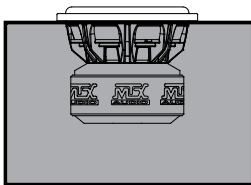

### Specifications :

Total Volume : 36,0 liters  
F-3 : 68Hz  
F-10 : 33Hz  
Qtc : 0,4  
Damping material : 50%

## ● #2 Vented enclosure : SQL, to play loud !

(F) Caisson bass-reflex pour jouer fort et tenir ses voisins éveillés, (E) Cajón Reflex, (D) Bassreflexgehäuse, (I) Cassa con accordo reflex, (P) Caixa reflex, (NL) Gepoorte behuizing, (RUS) Фазоинвертерный корпус, (RO) Incinta bas reflex, (FIN) Refleksi kotelo, (PL) Obudowa otwarta

# 63 liters

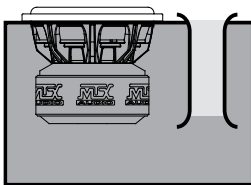

### Specifications :

Total Volume : 63 liters  
F-3 : 34Hz  
F-10 : 30Hz  
Fb : 42Hz  
Ripple : 6dB  
Vent diameter : 1x Aeroport 15cm  
Vent length : 25cm  
Damping material : 15%

## ● #3 Vented enclosure : SPL, to win competitions !

(F) Caisson bass-reflex pour jouer fort et tenir ses voisins éveillés, (E) Cajón Reflex, (D) Bassreflexgehäuse, (I) Cassa con accordo reflex, (P) Caixa reflex, (NL) Gepoorte behuizing, (RUS) Фазоинвертерный корпус, (RO) Incinta bas reflex, (FIN) Refleksi kotelo, (PL) Obudowa otwarta

# 79 liters

Designed for SPL competition

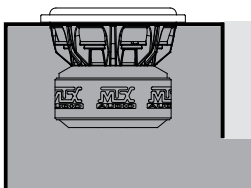

### Specifications :

Total Volume : 79 liters  
Fb : 54Hz  
Ripple : 9dB  
Slot port surface : 250cm<sup>2</sup>  
Vent length : 27cm  
Damping material : none

### Frequency Response

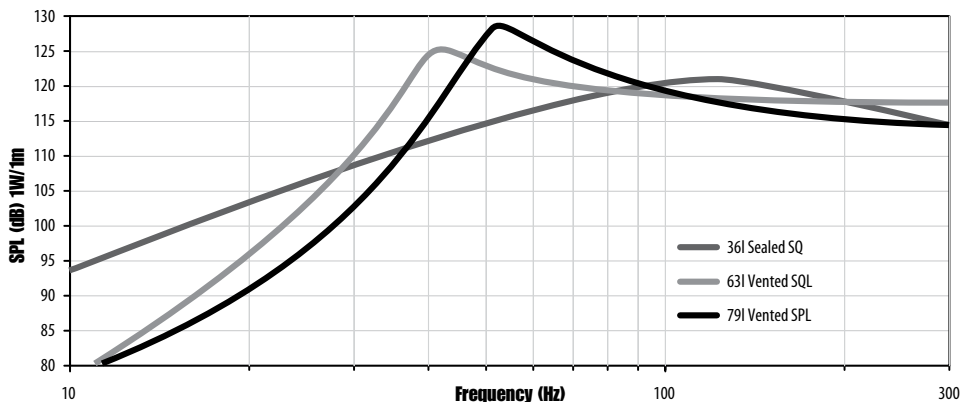

## ● #4 Dual Sealed Enclosure : SQ, to play clean and deep !

(F) Caisson clos pour qualité sonore et linéarité, (E) Cajón Sellado, (D) Geschlossenes Gehäuse, (I) Cassa a sospensione pneumatica, (P) Caixa fechada, (NL) Gesloten behuizing, (RUS) Закрытый корпус, (RO) Incinta in compresie, (FIN) Suljettu kotelo, (PL) Obudowa zamknięta

# 71 liters

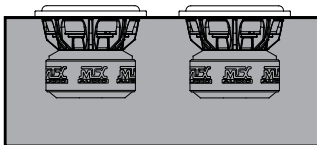

### Specifications :

Total Volume : 71,0 liters  
F-3 : 68Hz  
F-10 : 30Hz  
Qtc : 0,42  
Damping material : 50%

## ● #5 Dual Vented Enclosure : SQL, to play loud !

(F) Caisson bass-reflex pour jouer fort et tenir ses voisins éveillés, (E) Cajón Reflex, (D) Bassreflexgehäuse, (I) Cassa con accordo reflex, (P) Caixa reflex, (NL) Gevoorte behuizing, (RUS) Фазоинвертерный корпус, (RO) Incinta bas reflex, (FIN) Refleksi kotelo, (PL) Obudowa otwarta

# 122 liters

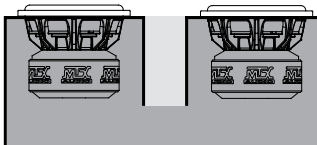

### Specifications :

Total Volume : 122 liters  
F-3 : 26Hz  
F-10 : 22Hz  
Fb : 35Hz  
Ripple : 3dB  
Vent area : 300cm<sup>2</sup>  
Vent length : 36cm  
Damping material : 15%

### Frequency Response

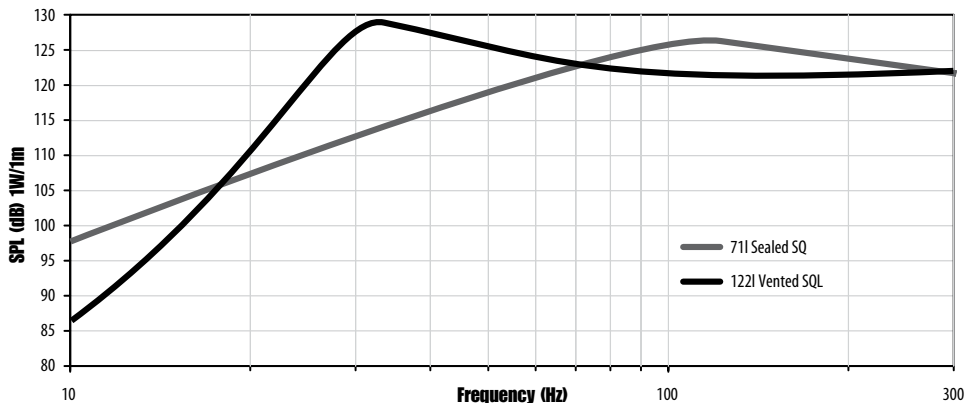

MTX is proud to be an  
American Audio Company since 1971.

Designed and Engineered by MTX in Phoenix - AZ, USA.  
© 2014 Mitek. All rights reserved. MTX is a registered trademark of Mitek.  
Due to continual product development, all specifications are subject to change without notice.  
Mitek - MTX 4545 East Baseline Rd. Phoenix, AZ 85042, USA

